

SALES AND TECHNICAL SERVICE CONTACTS

Australia:

Tel. (03) 9769.0666 • Fax (03) 9769.0699

China:

Tel. (10) 88570068 • Fax (10) 88570060

Egypt:

Tel. & Fax (02) 2758.683

Germany:

Tel. (07851) 9129-0 • Fax (07851) 9129-99

Greece:

Tel. (210) 823.5192 • Fax (210) 884.0210

Indonesia:

Tel. (21) 4584.2941 • Fax (21) 4584.2942

Japan:

Tel. (03) 3258.9565 • Fax (03) 3258.9567

Korea:

Tel. (02) 2278.5147 • Fax (02) 2264.1729

Malaysia:

Tel. (603) 5638.9940 • Fax (603) 5638.9829

Singapore:

Tel. 6296.7118 • Fax 6291.6906

South Africa:

Tel. (011) 615.6076 • Fax (011) 615.8582

Taiwan:

Tel. 886.2.2739.3014 • Fax 886.2.2739.2983

Thailand:

Tel. (662) 619.0708.11 • Fax (662) 619.0061

United Kingdom:

Tel. (01525) 850.855 • Fax (01525) 853.668

USA:

Tel. (401) 765.7500 • Fax (401) 765.7575

MAN84100
07/05

Instruction Manual

HI 84100 FREE & TOTAL SULPHUR DIOXIDE MINITRATOR for wine analysis

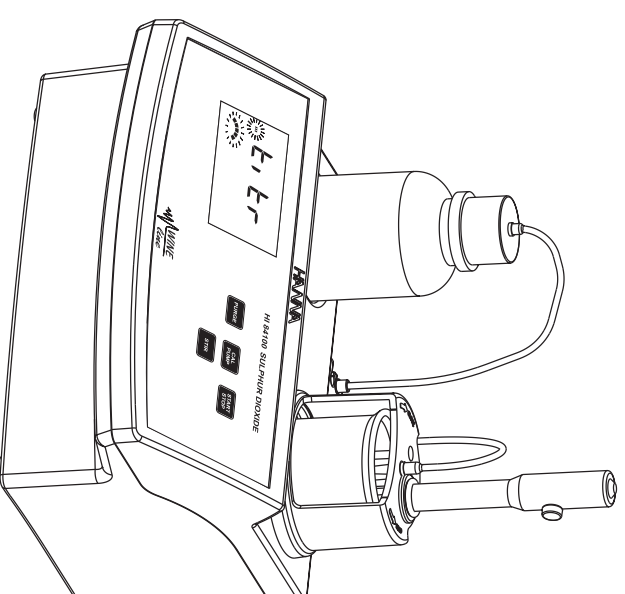

For e-mail contacts and a complete list of Sales and Technical offices, please see
www.hannainst.com.

Dear Customer,

Thank you for choosing a Hanna product. This manual will provide you with the necessary information for the correct use of the instrument. Please read it carefully before using the meter. If you need additional technical information, do not hesitate to e-mail us at tech@hannainst.com.

This instrument is in compliance with CE directives.

TABLE OF CONTENTS

PRELIMINARY EXAMINATION.....	3
GENERAL DESCRIPTION	3
SPECIFICATIONS	5
PRINCIPLE OF OPERATION	6
FUNCTIONAL DESCRIPTION	7
START UP	9
GUIDE TO DISPLAY CODES.....	10
TIPS FOR AN ACCURATE MEASUREMENT	12
FREE SO ₂ MEASUREMENT PROCEDURE.....	12
TOTAL SO ₂ MEASUREMENT PROCEDURE	13
PUMP CALIBRATION PROCEDURE	15
PUMP TUBE REPLACEMENT	15
FUSE REPLACEMENT	16
ELECTRODE CONDITIONING AND MAINTENANCE	16
ACCESSORIES	18
WARRANTY	19

WARRANTY

HI 84100 is warranted for two years against defects in workmanship and materials when used for its intended purpose and maintained according to the instructions.

This warranty is limited to repair or replacement free of charge.

Damage due to accident, misuse, tampering or lack of prescribed maintenance is not covered.

If service is required, contact your dealer. If under warranty, report the model number, date of purchase, serial number and the nature of the failure. If the repair is not covered by the warranty, you will be notified of the charges incurred.

If the instrument is to be returned to Hanna Instruments, first obtain a Returned Goods Authorization Number from the Customer Service Department and then send it with shipment costs prepaid. When shipping any instrument, make sure it is properly packaged for complete protection.

To validate your warranty, fill out and return the enclosed warranty card within 14 days from the date of purchase.

ACCESSORIES

REAGENT SETS

HI 70300L	Electrode storage solution (500ml)
HI 70635L	Cleaning solution for wine deposits (500ml)
HI 70636L	Cleaning solution for wine stains (500 ml)
HI 7082	Electrode filling solution (4 X 30 ml)
HI 84100-50	Titrant solution (100ml)
HI 84100-51	Alkaline reagent (500ml)
HI 84100-52	Acid reagent for Total SO ₂ determination (500 ml)
HI 84100-53	Acid reagent for Free SO ₂ determination (500 ml)
HI 84100-54	Stabilizer reagent (25 pcs)
HI 84100-55	Calibration standard (500 ml)

OTHER ACCESSORIES

HI 3148B	pH probe with shorter cable
HI 70483T	Tube set with cap for titrant bottle and tip
HI 731316	Stir bar (5pcs.)
HI 740036P	Beaker 50ml (10pcs.)
HI 740037P	Beaker 20ml (10pcs.)
HI 740198	Power cable

Recommendations for Users

Before using this product, make sure that it is entirely suitable for your specific application and for the environment in which it is used.

Operation of this instrument may cause unacceptable interferences to other electronic equipments, this requiring the operator to take all necessary steps to correct interferences.

Any variation introduced by the user to the supplied equipment may degrade the instrument EMC performance.

To avoid damages or burns, do not put the instrument in microwave ovens. For yours and the instrument safety do not use or store the instrument in hazardous environments.

PRELIMINARY EXAMINATION

Please examine this product carefully. Make sure that the instrument is not damaged. If any damage occurred during shipment, please notify your Dealer.

Each HI 84100 minititrator is supplied complete with:

- Reagents set for 20 titrations
- Two 50 mL beakers
- Two 20 mL beakers
- Scissors
- Tubes set with cap
- ORP probe
- Stir bar
- Power cable
- One 30 mL bottle of Refill Solution
- One 1 mL syringe
- Two sachets of cleaning solution for wine deposits
- Two sachets of cleaning solution for wine stains
- Instruction manual

Note: Save all packing material until you are sure that the instrument works correctly.

Any defective item must be returned in its original packing.

GENERAL DESCRIPTION

The HI 84100 is a low-cost, easy to use, microprocessor-based automatic titrator that benefits from Hanna's years of experience as a manufacturer of analytical instruments.

It has a simple and reliable peristaltic pump that ensure high dosing repeatability. By performing pump calibration with the provided Hanna standards, the instrument accuracy is assured.

The instrument comes with a pre-programmed analysis method designed for Free and Total Sulphur Dioxide measurements on wine samples. The instrument has a powerful and effective built-in algorithm to analyze the slope of the electrode response and to determine the reaction completion. This algorithm automatize the analysis, makes all the necessary calculations and assures a simple and effective interface for the user.

By simply pressing the START STOP button, the instrument will automatically make the titration up to the equivalence point. The result is immediately displayed in convenient units, then the instrument is ready for another titration.

SIGNIFICANCE OF USE

An important reason for adding SO_2 is to avoid oxidation. When there is oxygen around, SO_2 itself becomes oxidized before phenol compounds in the wine, and so acts as an oxygen scavenger. Also SO_2 suppresses the activity of enzymes that cause browning and other problems.

What is really protecting your wine is molecular SO_2 . When you add SO_2 , depending of circumstances, some of it immediately becomes bound. The relationship between the amount of added SO_2 and the amount of SO_2 remaining free is complex. It is clear, however, that it is largely governed by the total SO_2 content of the wine. The rate of binding decreases as the free SO_2 concentration increases. The exact relationship between free and bound (total – free) SO_2 will vary from wine to wine.

Below 30-60 ppm, 33% to 50% of SO_2 addition becomes bounded. What remains is called “free” and it is divided in two parts. The larger, and relatively ineffective free part is “bisulphite” (HSO_3^-). The smaller part of the free is the active molecular SO_2 . The amount of molecular SO_2 in your wine depends both on the level of free SO_2 present as well as pH. For instance, at pH 3.2, the amount of free SO_2 for 0.8 ppm molecular SO_2 is 22 ppm. At pH 3.5, you will need 43 ppm free - essentially double.

Free SO_2 concentration (ppm) for 0.8 ppm molecular SO_2 :

pH	3.0	3.1	3.2	3.3	3.4	3.5	3.6	3.7	3.8	3.9
Free SO_2	14	18	22	28	35	44	55	69	87	109

In most situations, 0.8 ppm molecular SO_2 during bulk storage and at bottling will provide you with adequate protection from oxidation and bacterial action. This includes prevention of malolactic bacteria as well.

It is important to remember that the amount of free SO_2 in the wine depends on three things: how much is added, how much was present before the addition and how much of your addition promptly becomes bound.

The level at which molecular SO_2 can be detected by the human senses is about 2.0 ppm. This is also the level which is needed for maximum protection of your wine. This is particularly true in the case of sweet, and most notably, botrytised wines.

The Hanna HI 84100 offers the possibility to test free or total SO_2 in all the wines including the red ones, that are difficult to test with manual methods because the color changes are hardly seen.

For faster response, unscrew the fill hole screw during measurements.

STORAGE PROCEDURE

To minimize clogging and assure a quick response time, the glass bulb and the junction of the electrode should be kept moist and not allowed to dry out.

Replace the solution in the protective cap with a few drops of **HI 70300** Storage Solution or, in its absence, Filling Solution (**HI 7082**). Follow the Preparation Procedure before taking measurements.

Note: NEVER STORE THE ELECTRODE IN DISTILLED OR DEIONIZED WATER.

PERIODIC MAINTENANCE

Inspect the electrode and the cable. The cable used for connection to the instrument must be intact and there must be no points of broken insulation on the cable or cracks on the electrode stem or bulb. Connectors must be perfectly clean and dry. If any scratches or cracks are present, replace the electrode. Rinse off any salt deposits with water.

Probe Maintenance

Refill the reference chamber with fresh electrolyte (**HI 7082**). Allow the electrode to stand upright for 1 hour. Follow the Storage Procedure above.

CLEANING PROCEDURE

- *Wine deposits*: Soak in Hanna **HI 70635** cleaning solution for 15 minutes
- *Wine stains*: Soak in Hanna **HI 70636** cleaning solution for 15 minutes.

IMPORTANT: After performing any of the cleaning procedures, rinse the electrode thoroughly with distilled water, refill the reference chamber with fresh electrolyte and soak the electrode in **HI 70300** Storage Solution for at least 1 hour before taking measurements.

FUSE REPLACEMENT

To change the fuse follow next steps:

- Disconnect the power cord from the rear panel of the instrument.
- Pull out the fuse holder located near the power cord connector.
- Replace the fuse with a similar one.
- Push the fuse holder with the fuse in the appropriate place.

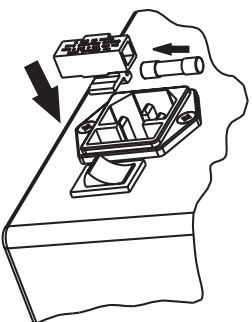

ELECTRODE CONDITIONING & MAINTENANCE

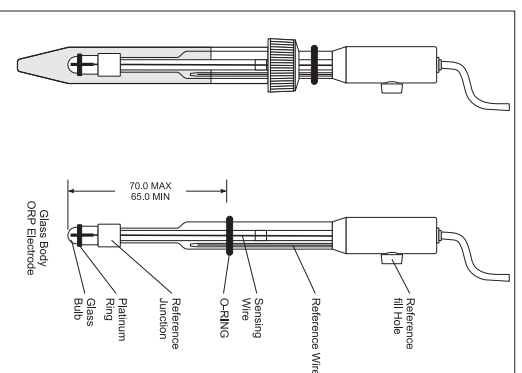

PREPARATION PROCEDURE

Remove the protective cap of the ORP electrode (**HI 3148B**).

DO NOT BE ALARMED IF SALT DEPOSITS ARE PRESENT. This is normal with electrodes. They will disappear when rinsed with water.

During transport, tiny bubbles of air may form inside the glass bulb affecting proper functioning of the electrode. These bubbles can be removed by “shaking down” the electrode as you would do with a glass thermometer.

If the bulb and/or junction is dry, soak the electrode in **HI 70300** Storage Solution for at least one hour. If the filling solution (electrolyte) is more than 2½ cm (1”) below the fill hole, add **HI 7082** 3.5M KCl Electrolyte Solution.

SPECIFICATIONS

Range	0 to 400 ppm of SO ₂
Resolution	1 ppm
Accuracy	5% of reading
Method	Ripper titrimetric method
Principle	Equivalence point redox titration
Sample volume	50 mL
ORP Electrode	HI 3148B (included)
Pump debit	0.5 mL/min
Stirring speed	1500 rpm
Environment	0 to 50 °C (32 to 122 °F); max 95% RH non-condensing
Power supply	220V/50Hz; 10VA
Dimensions	208 x 214 x 163 mm (8.2 x 8.4 x 6.4”) (with beaker)
Weight	2200 g (77.6 oz.)

REQUIRED REAGENTS

Code	Description	Quantity/test
HI 84100-50	Titrant (for Free & Total SO ₂)	
HI 84100-51	Alkaline Reagent (for Total SO ₂)	5 mL
HI 84100-52	Acid Reagent (for Total SO ₂)	5 mL
HI 84100-53	Acid Reagent (for Free SO ₂)	5 mL
HI 84100-54	Stabilizer (for Free & Total SO ₂)	1 packet
HI 84100-55	Standard (for Free & Total SO ₂)	50 mL

PRINCIPLE OF OPERATION

Determination of sulphur dioxide in wine samples is made by titration of the sulphur dioxide present in wine with iodate. In this procedure an excess of iodine is added to the wine sample and it is titrated with iodate.

The iodate reacts with iodide and the sulphuric acid present in the wine and produces iodine:

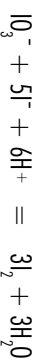

The iodine produced in the reaction above reacts then with the sulphur dioxide:

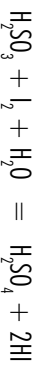

For precise results it is very important to know the exact sample volume, titrant volume and concentration.

The peristaltic pump has a good repeatability but the dosing volume depends on many factors as the diameter of the tube or the tube stretching. To compensate for all this errors, the pump need to be calibrated. The calibration of the pump is also needed in order to have high precision of the titrations.

The calibration procedure is in fact the analysis of a known solution. By doing this, the instrument makes a differential analysis between the standard and the wine sample. The pump volumetric debit and the real concentration of the titrant is compensated. Only the sample volume has to be precisely known.

PUMP CALIBRATION PROCEDURE

Warning: The calibration of the pump must be performed each time the pump tube, the reagent bottle or the pH electrode is changed. It is recommended to perform the pump calibration before each set of measurements.

- To prepare the sample for calibration, follow the measurement procedure for Free or Total SO₂ measurements by using **HI 84100-55** Standard instead of wine sample.

- After sample preparation, press the CAL PUMP button. Std will blink on the screen.

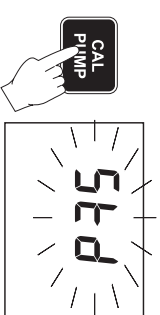

- Press START STOP in order to start the system calibration.



- At the end of the calibration procedure done appears for a few seconds and then the meter automatically returns to measurement mode.

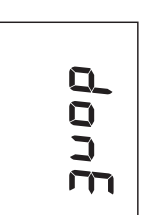

PUMP TUBE REPLACEMENT

To remove the tube of the peristaltic pump follow next steps:

- Detach the old tube system from the reagent bottle.
- Grasp one fixing ring of the peristaltic pump tube.
- Pull the tube until it's taken out from its location.
- Remove the other side of the tube.

To mount the new peristaltic pump tube follow next steps:

- Position one peristaltic pump fixing ring on its location.
- Stretch the tube over the peristaltic pump cylinders.
- Fix the second pump fixing ring on its location.
- Attach the tube to the reagent bottle.

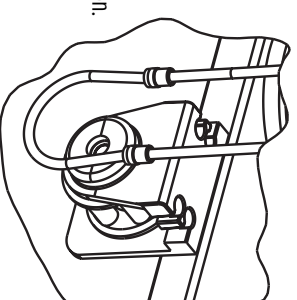

Note: Purge the peristaltic pump until drops of reagent appears on the dosing tip by pressing the PURGE button.

- Add the content of one powder packet of **HI 84100-54** Stabilizer into the beaker. Press the STIR button to start mixing. After 10 seconds, press again STIR to stop the stirrer.

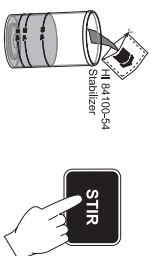

- Place the probe holder on the top of the beaker and secure it by turning clockwise.

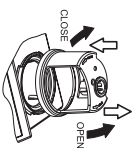

- Immerse the ORP electrode approximately 2 cm (0.8") into the sample to be tested while paying attention to not touch the stir bar.

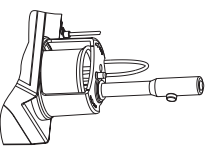

- Insert the dosing tip in the appropriate holder place and pay attention to not be immersed into solution.

- Press the START STOP button to start the titration. The display will show "titr" during titration, along with stirrer and pump tags blinking on the LCD.



- At the end of the titration, the Sulphur Dioxide concentration is displayed in mg/L (ppm).



Note: If the equivalence point is not reached or it is not recognized because of the noisy solution, an error message will be displayed.

FUNCTIONAL DESCRIPTION

INSTRUMENT DESCRIPTION

FRONT PANEL

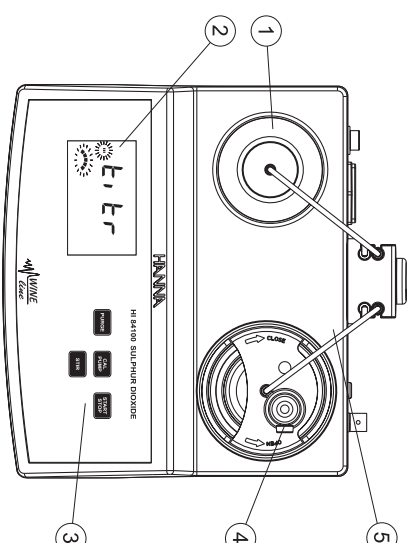

- 1) Titrant bottle
- 2) Liquid Crystal Display (LCD)
- 3) Keypod
- 4) Electrode holder
- 5) Peristaltic pump tube

REAR PANEL

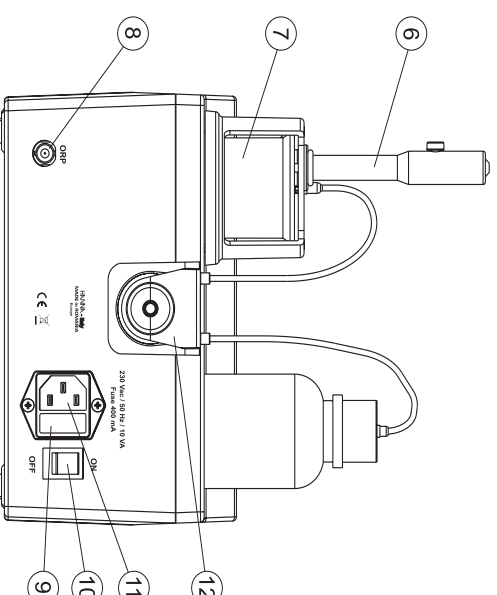

- 6) ORP Electrode
- 7) Beaker
- 8) BNC electrode connector
- 9) Fuse
- 10) Power switch
- 11) Power cable connector
- 12) Peristaltic pump

KEYPAD DESCRIPTION

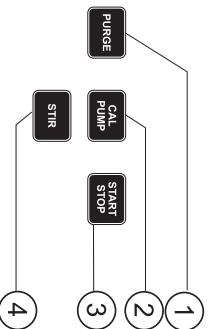

- 1) **PURGE** - to start/stop purging (max purging time is 5 min)
- 2) **CAL PUMP** - to enter pump calibration mode
- 3) **START STOP** - to start/stop titration or pump calibration
- 4) **STIR** - to start/stop the stirrer while in measurement or purging mode

LCD DESCRIPTION

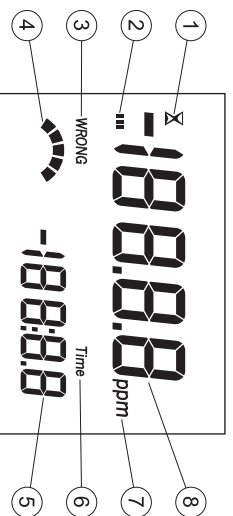

- 1) Stability indicator: when the pump calibration is in progress
- 2) Stirrer active tags
- 3) Calibration messages
- 4) Pump active tags
- 5) Four digit secondary display
- 6) "Time" tag: when the time is displayed on the secondary display
- 7) "ppm" tag: when the titration result is displayed on the primary display
- 8) Four digit and half main display

- Immerse the ORP electrode approximately 2 cm (0.8") into the sample to be tested while paying attention to not touch the stir bar.

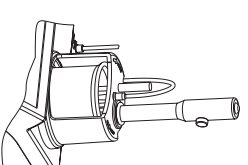

- Insert the dosing tip in the appropriate holder place and pay attention to not be immersed into solution.

- Press the START STOP button to start the titration. The display will show "titr" during titration, along with stirrer and pump tags blinking on the LCD.



- At the end of the titration, the Sulphur Dioxide concentration is displayed in mg/L (ppm).



Note: If the equivalence point is not reached or it is not recognized because of the noisy solution, an error message will be displayed.

TOTAL SO₂ MEASUREMENT PROCEDURE

- Fill the 50 mL beaker up to the 50 mL mark with the wine sample, place the stir bar into the beaker and put the beaker in the appropriate place on the minititrator top.
- Fill the 20 mL beaker up to the 5 mL mark with the **HI 84100-51 Alkaline Reagent** and add the content to the 50 mL beaker.
- Press the STIR button and mix the content for about 10 seconds. Stop the stirrer by pressing again STIR and wait for 15 minutes.
- Fill the 20 mL beaker up to the 5 mL mark with the **HI 84100-52 Acid Reagent** and add the content to the 50 mL beaker.

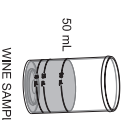

TIPS FOR AN ACCURATE MEASUREMENT

The instructions listed below should be carefully followed during testing to ensure best accuracy.

- Purge the peristaltic pump to have fresh titrant when starting a new analysis or calibration.
- Calibrate the peristaltic pump before performing an analysis.
- Analyze the wine immediately after the sample is obtained.
- Clean the electrode with the **HI 700635** or **HI 700636** cleaning solution, specially made for wine industry, if it was unused for a long time.

FREE SO₂ MEASUREMENT PROCEDURE

Warning: Make sure the pump was calibrated before performing sulphur dioxide wine sample analysis.

- Fill the 50 mL beaker up to the 50 mL mark with the wine sample, place the stir bar into the beaker and put the beaker in the appropriate place on the minitractor top.
- Fill the 20 mL beaker up to the 5 mL mark with the **HI 84100-53 Acid Reagent** and add the content to the 50 mL beaker.
- Press the **STIR** button and mix the content for about 10 seconds. Stop the stirrer by pressing again **STIR** and wait for 15 minutes
- Add the content of one powder packet of **HI 84100-54 Stabilizer** into the beaker. Press the **STIR** button to start mixing. After 10 seconds, press again **STIR** to stop the stirrer.
- Place the probe holder on the top of the beaker and secure it by turning clockwise.

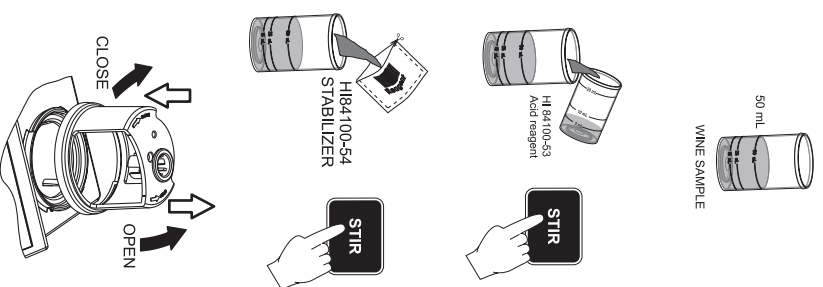

START UP

- Place the instrument on a flat table. Do not place the instrument on direct sun light.
- Connect the titrator to mains socket with ground connection and the correct voltage and frequency. See the label on the instrument rear for this.
- Place the peristaltic pump tube on the pump. See the Pump Tube Replacement section for the procedure.
- Remove the reagent bottle cap and place the bottle cap of the tubes set. Place the reagent bottle in the appropriate place on the titrator top.
- Connect the tubes with the peristaltic pump (inlet tube is connected with the reagent bottle, outlet tube is connected with the dosing tip).
- Turn the instrument ON using the power switch from the rear panel of the instrument and wait until it displays dashes.

GUIDE TO DISPLAY CODES

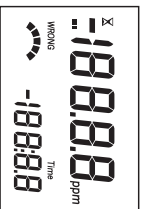

This prompt appears for a few seconds each time the instrument is turned ON.

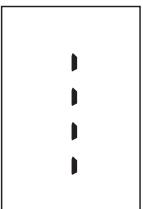

Main screen display.

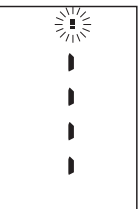

Main screen display with stirrer active.

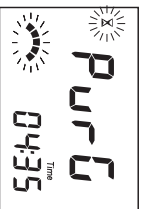

Purging mode message.

PUMP CALIBRATION MESSAGES

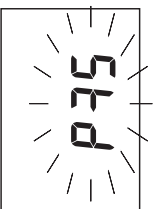

This screen appears each time the meter enters pump calibration mode. The meter is ready to start pump calibration by pressing the START STOP button.

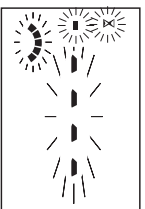

This screen appears while pump calibration is in progress. Pressing CAL PUMP or START STOP button, the minitrator returns to the main screen.

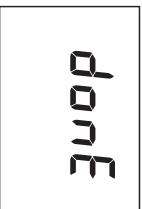

This prompt appears for a few seconds before returning to the main screen, when pump calibration is done.



This error message appears when the sample concentration exceeds 400 ppm.

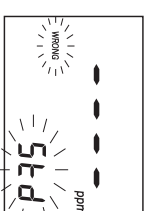

The used standard solution is wrong.

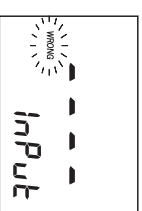

This error message appears when the input readings (mV) exceed the input limits ($\pm 1000\text{mV}$).

TITRATION MESSAGES

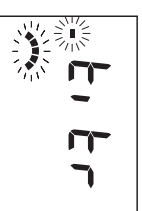

This screen appears each time the minitrator enters TITRATION mode. Press the START STOP button in order to stop the titration and return to the main screen.



The titration result, expressed as concentration of sulphur dioxide in mg/L, is displayed at the end of the titration process. Press the START STOP button to return to the main screen.

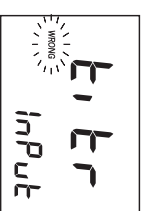

This error message appears when the input reading exceeds the input limits ($\pm 1000\text{mV}$).

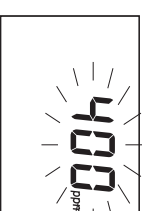

This screen appears when the sample concentration exceeds 400 ppm.